



# INSTALLATION & USER MANUAL

## HC Digital Automatic Humidistat (Y3760)



CONTROLS  
506808-01  
3/2016  
Supersedes 6/2011



**THIS MANUAL MUST BE LEFT WITH THE HOMEOWNER FOR FUTURE REFERENCE**

### Table of Contents

Product Description .....	1
Installation .....	2
Electrical connections: .....	3
User Interface and Modes .....	5
Configuration (Setting DIP Switches, Parameters, Auto humidity control, Sensor calibration) .....	6
Functions .....	7
Parameters .....	8
Alarms and Signals .....	8
Technical Specifications and Wiring .....	9
Replacement Parts .....	9

### **! NOTICE**

The humidistat must be installed in accordance with all local and national standards.

Installation, adjustments, alterations, service and maintenance must be performed by a qualified service technician.

### Product Description

The HC Digital Automatic Humidistat is a programmable control for HCSteam residential humidifiers. While the HC Digital Automatic Humidistat may be used for control of other humidification or dehumidification appliances, its operating modes are designed for modulating control of the HCSteam electrode steam humidifiers.

When properly installed and configured, the HC Digital Automatic Humidistat will use information from the environment including Relative Humidity, Outdoor Temperature and Home Construction to determine the Ideal Humidity and the Optimum Humidifier Output.

The HC Digital Automatic Humidistat includes an Indoor Temperature Sensor, Indoor Humidity Sensor and Control Unit. A separate Outdoor Sensor is supplied.

### Humidistat Dimensions

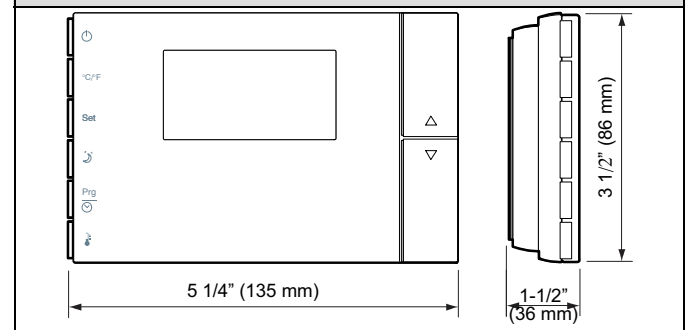

### Disposal

The product is made from metal and plastic parts. All parts must be disposed of according to the local standards on waste disposal.



## Installation

1. Open the product by detaching the front from the mounting base, as shown in figure 1:
  - Remove the screw holding the locking tab in place (detail A).
  - Slide the plastic tab back as shown to remove it from the base (detail B).
  - Press the tab on the front with the flat-head screwdriver into the slit in the middle on the bottom of the case (detail C) while lifting the front panel upwards (detail D).

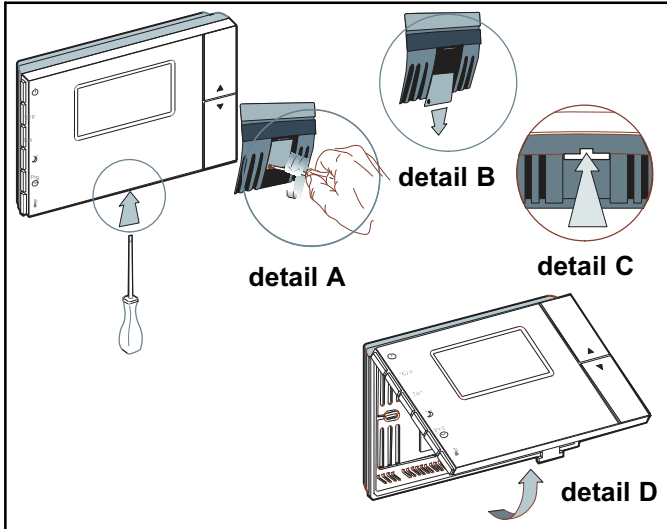

**Figure 1. Opening the humidistat**

2. Disconnect the flat front-rear connector cable from the front panel.
3. Fasten the humidistat base to the wall using the screws supplied.
4. Access the terminal block by squeezing the clips on the terminal cover.
5. Make the necessary connections and run the wires through the hole in the middle of the base. Separate

the connection and control cables from the relay cables. The diagrams are shown under *Electrical Connections* (Page 3).

## **⚠ NOTICE**

**Make sure all connections are complete before re-connecting the flat cable and front part of the humidistat.**

**For the purposes of electrical safety, once the controller has been installed, replace the plastic locking tab in the humidistat base.**

**Table 1. Connections and DIP switches**

Connector	Function
J1	Not used
J2	Not used
Flat front-rear	The flat front-rear connection cable must be re-connected in the position defined by the plastic part to ensure correct polarity.
DIP switches	For configuring humidification/dehumidification modes.

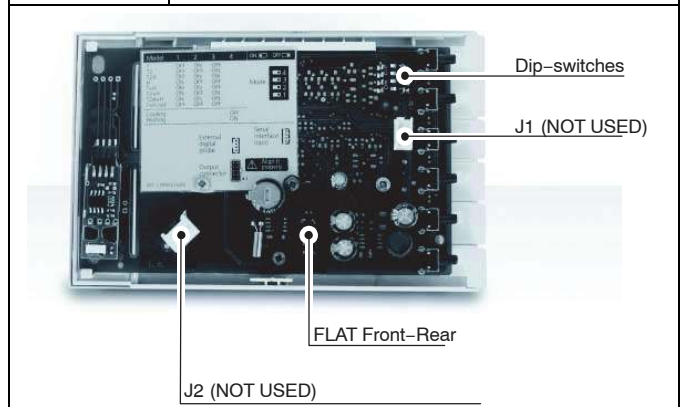

## Electrical connections

### Connect the HC Digital Automatic Humidistat to HCSteam Humidifier for Modulating Operation

**IMPORTANT** - Be sure the connections are made as described in the following and as shown in figure 2.

1. Connect HCSteam Humidifier terminal 24V to HC Digital Automatic Humidistat terminal 6-G.
2. Connect HCSteam Humidifier terminal GND to HC Digital Automatic Humidistat terminal 5-G0.
3. Connect HCSteam Humidifier terminal IN to HC Digital Automatic Humidistat terminal 7-AOUT.

#### NOTES -

- Modulating operation requires that the signal type be changed at the HCSteam Humidifier. See HCSteam Humidifier Installation Instruction Manual 506746-01.
- Verify DIP switch settings per figure 2.

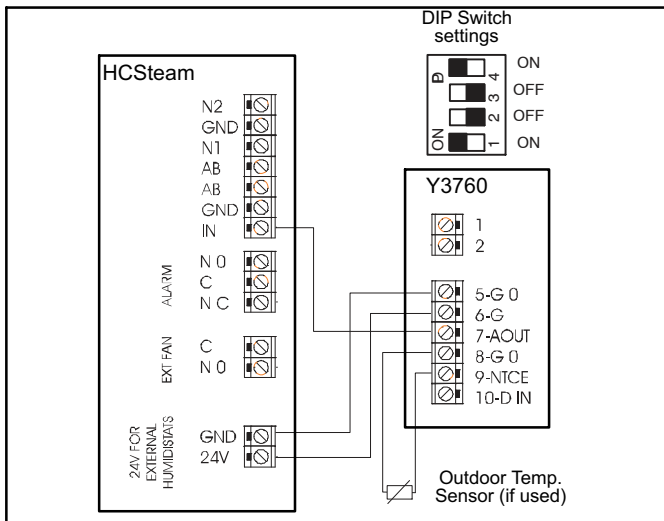

**Figure 2. Connect for Modulating Operation**

### Connect the HC Digital Automatic Humidistat to HCSteam Humidifier for ON-OFF Operation

**IMPORTANT** - Be sure the connections are made as described in the following and as shown in figure 3.

1. Connect HCSteam Humidifier terminal 24V to HC Digital Automatic Humidistat terminal 6-G.
2. Connect HCSteam Humidifier terminal GND to HC Digital Automatic Humidistat terminal 5-G0.
3. Connect HCSteam Humidifier terminal GND to HC Digital Automatic Humidistat terminal 1.
4. Connect HCSteam Humidifier terminal IN to HC Digital Automatic Humidistat terminal 2.

Connect HCSteam Humidifier terminals 24V and GND to HC Digital Automatic Humidistat terminals 6-G and 5-G0 respectively. Do not reverse these connections. Connect HC Digital Automatic Humidistat terminal 1 and 2 to HCSteam terminal GND and IN respectively. Do not reverse these connections (see figure 3).

#### NOTES -

- HCSteam humidifiers are configured for On-OFF operation from the factory. See HCSteam Humidifier Installation Instruction Manual 506746-01.
- Verify Dip Switch Settings per figure 3.

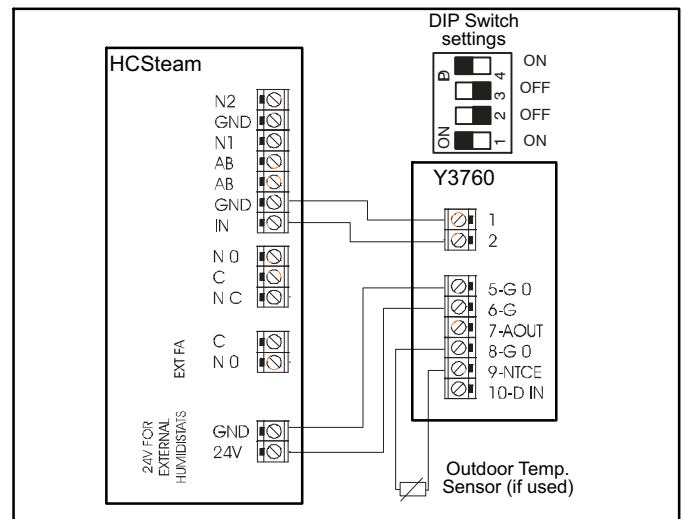

**Figure 3. Connect for ON-OFF Operation**

## Placement of Remote Outdoor Temperature Sensor

- Outdoor temperature sensor should not be mounted on the south side of the house or in direct sunlight.
- Outdoor temperature sensor may not be located closer than 4 feet to exhaust vents, dryer vents, etc.
- If outdoor temperature sensor is mounted in fresh air intake duct, make sure the probe is no further than 1 foot from outside wall.
- Make sure wiring for outdoor temperature sensor is not close to other wires particularly high voltage.
- Outdoor temperature sensor must be at least 6" above expected snow line.
- Maximum conductor length of the Outdoor Temperature Sensor is 100 feet (30m) of standard thermostat cable (twisted pair not required).
- Connect Outdoor Temperature Sensor to terminals #8 and #9.

**Table 2. Outdoor Sensor Temperature / Resistance Range**

Temperature °F (°C)	Resistance Value (KOHM)			Temperature °F (°C)	Resistance Value (KOHM)		
	Maximum	Standard	Minimum		Maximum	Standard	Minimum
-40.0 (-40)	196	188	181.1	41.0 (5)	22.5	22.1	21.7
-29.2 (-34)	142	137	131.8	50.0 (10)	18.2	18	17.7
-20.2 (-29)	109	106	102.2	60.8 (16)	14.3	14.1	13.9
-9.4 (-23)	80.7	78.3	75.93	69.8 (21)	11.8	11.6	11.6
-0.4 (-18)	63.3	61.5	59.81	80.6 (27)	9.38	9.28	9.18
10.4 (-12)	47.7	46.5	45.31	100.4 (38)	6.33	6.24	6.15
19.4 (-7)	37.9	37.1	36.2	122.0 (50)	4.24	4.16	4.08
30.2 (-1)	30	28.5	27.89	136.4 (58)	3.28	3.2	3.1

## User Interface and Modes

### Display and buttons

Figure 4 below shows the humidistat with its control buttons and its display, along with a key of what each of the symbols represent. Table 3 describes how the buttons operate.

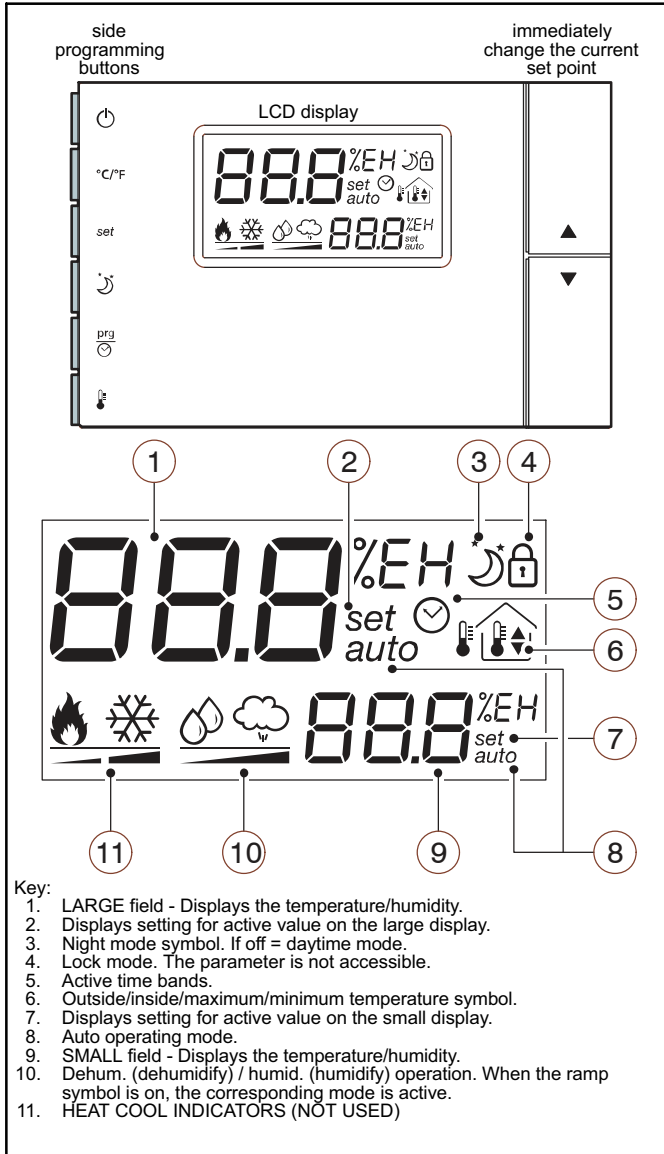

Figure 4. Humidistat display and buttons

Table 3. Humidistat buttons description

	On/Off .
°C/°F	Selects the temperature display mode, degrees Celsius or Fahrenheit. Whenever pressed switches the temperature units.
set	Used to display and where necessary change, using the UP and DOWN buttons, the set point displayed in the SMALL field. If held for more than 5 seconds, accesses the parameters menu.  To scroll the various parameters use UP and DOWN. To edit them, press the SET button a second time and to exit the parameters menu press the PRG button. Access to the parameters is protected by password if parameter PS is enabled.
	Change mode manually: activates the opposite function (and the corresponding set point) to the current (night if day or day if night), for the set time. To change or reset the timer use the UP and DOWN buttons to increase or decrease the time. Press a second time to exit and return to the main menu. If sleep mode is already active, pressing the button shows the time remaining on the timer.  E.g.: if the humidistat is in Night mode (moon symbol on) from time band, pressing this button activates daytime mode (moon symbol off ) for the set time.
prg	Accesses the menu for setting the clock, the time bands, and the default value of the timer. When first pressed, displays the current time (RTC); to display the other parameters, use the UP and DOWN arrows. To set a new value, press SET when displaying the desired parameter and change the value using the UP and DOWN buttons. Press a second time to exit and return to the main menu.
	Accesses the menu for displaying the temperature: current, maximum and minimum outside (from instrument power on), inside and outside. To display the various temperatures, press the button repeatedly. Their meaning is displayed in the box with the home symbol.  Also displays the value of the analogue output when "Out" is shown in the SMALL field.
	From the main menu increases the value of the set point displayed in the LARGE field. In the other menus displays the variables or the parameters, or alternatively sets the value after having pressed SET.
	From the main menu decreases the value of the set point displayed in the LARGE field. In the other menus displays the variables or the parameters, or alternatively sets the value after having pressed SET

The values displayed in the LARGE and SMALL fields (shown in figure 4) depend on the setting of parameter **dyS** as shown in table 4.

Table 4. dyS parameter values

dyS	LARGE field (1)	SMALL field (9)
1	humidity	humidity set point
2	humidity set point	humidity
3	humidity set point	
4	humidity	

## Configuration

### NOTICE

Before closing the cover, the mode must be selected using the dip switches.

Important: Setting the dip switches incorrectly will cause the humidistat to malfunction.

**Table 5. Setting humidistat control type**





DIP switch positions				Humidistat is set for:
1	2	3	4	
ON	OFF	OFF	ON	Humidifier Control (default)
ON	OFF	OFF	OFF	Dehumidifier Control

### Setting parameter

The parameters for all operating modes also feature a default value. These values can be restored by running the "Factory set" operation. See the table of parameters for details of the default values and settings.

- **SET POINT:** depending on the operating mode, different set points are used. To set these, access (SET button – press and hold for 5 seconds) the mode for setting the parameters and set the corresponding values. For the current mode only, the value can be accessed directly using UP, DOWN or set, UP, DOWN (for the SMALL field).  
With the desired parameter displayed, use the UP/DOWN buttons, then press SET - the parameter starts flashing. Edit the value using the UP/DOWN buttons and then press SET. To exit the menu, press the PRG button again.
- **Clock, TIME BANDS Prg/(clock):** Press the corresponding button to display and if necessary set the default duration of the change mode timer, display or set the RTC clock and set the Day and Night time bands. Initially, at least the set point for humidity control need to be checked/set:
  - Humidification set point (def. 30.0 % RH)
  - Dehumidification set point (def. 70.0 % RH)

**Table 7. Auto humidity and calibration parameters**

Code	Description of the parameter	Range	Default	Unit of measure
<b>AUt</b> 	Humidity set point level compensated according to the outside temperature. If humidity control is featured, the ambient humidity is controlled with an automatic set point, defined from 1H to 7H using the buttons, as specified in Table 8. If set to OFF, the mode is disabled. Setting one of the levels shown in the table, the controller independently sets a humidity set point in relation to the outside temperature measurement	OFF 1H to 7H	OFF	—
<b>CAL+ Int</b> 	Inside temperature calibration, digital sensor or NTC (within a max. of $\pm 10^\circ\text{C}$ )	-10 to 10	0.0	$^\circ\text{C}$
<b>CAL+ Est</b> 	Outside temperature calibration, NTC sensor (within a max. of $\pm 10^\circ\text{C}$ )	-10 to 10	0.0	$^\circ\text{C}$
<b>CAL+ HUn</b> 	Digital humidity sensor calibration (within a max. of $\pm 15\% \text{rH}$ ) Within a maximum of $\pm 15\% \text{rH}$	-15 to 15	0.0	%rH

**Table 6. Operating mode defaults**

rtC	clock hh:mm	-
SLP	manual changeover duration	def. 8 hours
dAy	start day band	def. 08:00
nIt	start night band	def. 20:00

- To disable the time bands function, set parameter rtC off :
  - Select parameter rtC using PRG/CLOCK and set the value using the DOWN button.
  - When reaching 00:00 using the DOWN button the function will be off.

When parameter rtC is set to off the operating mode is always daytime, and consequently only the daytime set points are used, the night settings are only used when the NIGHT button is pressed, manually changing mode.

### Auto humidity control

In addition to the modes featured by the control algorithms, the humidity can be controlled automatically, based on the reading of the outside temperature sensor. The aim of this type of control is to simplify the setting of the HC Digital Automatic Humidistat, changing the humidity control according to the outside environmental conditions and therefore minimize the discomfort of the user when moving into/out of the air-conditioned environment. This operating mode is selected by setting parameter AUt (see table 7).

- According to the level set using the up/down buttons, with a value from 1H to 7H, a different humidity set point trend is defined. To disable this operating mode, in the parameters menu set the value of AUt = 0. AUTO mode for the humidification control is only possible if the outside temperature sensor is installed.
  - AUTO mode for the humidification control is only possible if the outside temperature sensor is installed.

### Sensor Calibration

To make up for any errors due to the length of the cables or the sensors connected, the controller features two parameters for calibrating the values read by the sensors. The CAL parameters are also shown in table 7.

**Table 8. Humidity set point according to the setting of AUt (outside temperature in degrees)**

AUt Level	Below -9.4°F (-23°C)	-9.4 to 1.4°F (-23 to -17°C)	1.4 to 10.4 °F (-17 to -12°C)	10.4 to 21.2°F (-12 to -6°C)	21.2 to 30.2°F (-6 to -1°C)	30.2 to 39.2°F (-1 to 4°C)	39.2 to 50°F (4 to 10°C)	Above 50°F (10°C)
1H	10%	10%	10%	10%	15%	20%	25%	30%
2H	10%	10%	10%	15%	20%	25%	30%	35%
3H	10%	10%	15%	20%	25%	30%	35%	40%
4H	10%	15%	20%	25%	30%	35%	40%	45%
5H	10%	20%	25%	30%	35%	40%	45%	45%
6H	10%	25%	30%	35%	40%	45%	45%	45%
7H	10%	30%	35%	40%	45%	45%	45%	45%

**Functions**

**General**

This section describes the humidity control modes available. The control modes are based on parameters, divided into two levels (see figure 5):

- Level 1, basic: main settings, always required;
- Level 2, advanced: used to customize the features of the controller.

*IMPORTANT - Some parameters included in the advanced level, are forced to take on default values in the basic level or are linked to other parameters in the basic level. This especially applies to the control differentials. In each operating mode, the links between the various basic and advanced levels are specified.*

- if level 1 is active, the level 2 parameters are not used but rather replaced by the default values or by the link value with the level 1 parameters;
- the level 2 parameters are effectively used when level 2 is activated.

**Humidity control**

This type of control is used to send a start signal to a humidifier or dehumidifier. The modulating output can only be used for humidification control. Examples of using of the analog output:



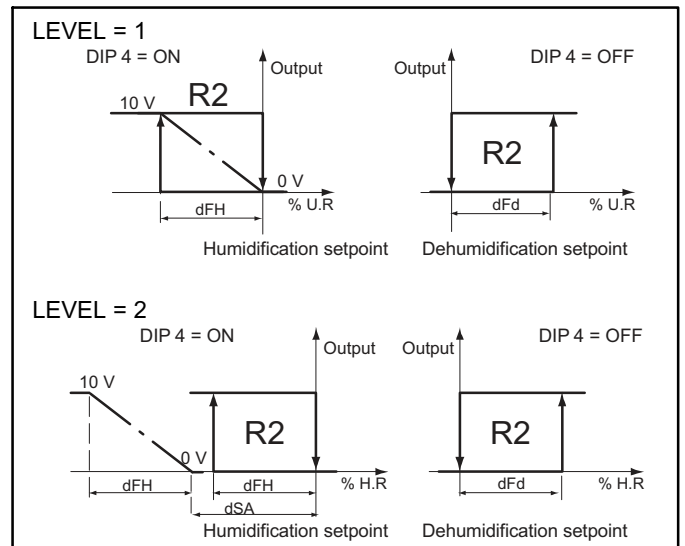







- for proportional humidity control of HCSteam humidifiers;
- as an additional step to the relay for humidity control. (See the DIP switch settings in table 5, Page 6.)



**Figure 5. Level functions**

**Table 9. Humidity control indicators & defaults**

Code	Description	Default	Level
	Humidification set point	50.0 % rH	1
	Dehumidification set point	70.0 % rH	1
dFH	Humidification differential	5.0 % rH	1
dFd	Dehumidification differential	5.0 % rH	1

Parameters					
code	parameter	range	default	unit of measure	note
	<b>Humidification set point.</b>	10 to 70	50.0	% rH	
	<b>Dehumidification set point.</b>	10 to 70	70.0	% rH	
dFH	 <b>Humidity differential for activating analog output and relay.</b>	1 to 20	5.0	% rH	
dFd	 <b>Dehumidification differential activating relay.</b>	1 to 20	5.0	% rH	
SFH	  <b>Humidification/dehumidification status in day and night mode.</b> Activates or deactivates humidification or dehumidification control (based on DIP 4) with the time bands. The parameter can have the following three values: 0 Time bands disabled. The humidification/dehumidification control is always active, if featured, and is configured in relation to dip4. 1 Time bands enabled. When switching to the daytime band, humidification/dehumidification control (depends on dip4) is activated. When switching to the night band, humidification/dehumidification control (depends on dip4) is deactivated. 2 Time bands enabled. When switching to the daytime band, humidification/dehumidification control (depends on dip4) is deactivated. When switching to the night band, humidification/dehumidification control (depends on dip4) is activated.	0 to 2	0	—	
AUt	 <b>Humidity set point automatically compensated by outside temperature.</b> If humidity control is featured, the ambient humidity is controlled with an automatic set point, defined from 1H to 7H using the buttons, as specified in the corresponding table (see Page 6). If set to OFF the mode is disabled. Setting one of the levels in the table, the controller independently sets a humidity set point in relation to the outside temperature.	OFF 1H to 7H	OFF	—	
CAL+Int	 <b>Inside temperature calibration, digital sensor or NTC.</b> Within a maximum of $\pm 10$ °C.	-10 to 10	0.0	°C	
CAL+Est	 <b>Outside temperature calibration, NTC sensor.</b> Within a maximum of $\pm 10$ °C.	-10 to 10	0.0	°C	
CAL+HUn	 <b>Digital humidity sensor calibration.</b> Within a maximum of $\pm 15\%$ rH.	-15 to 15	0.0	% rH	
LE	<b>Parameter access level.</b> Levels of access that control parameters for the active mode: 1 Basic access: only the essential parameters for correct operation. 2 Advanced access: used to set all the parameters for the selected control mode.	1, 2	1	—	
Unt	 <b>Temperature display mode.</b> Sets the temperature display mode, in degrees Fahrenheit or Centigrade. Unlike direct selection using the button, if changing the temperature display mode using parameter Unt, this becomes the default display mode when switching the instrument on.	°C, °F	°C	—	

Alarms and Signals			
code on large field display	description	reset	effect
EE	system/memory error	manual by removing power	stops all outputs
Eth	temperature+humidity sensor fault	automatic	stops all outputs and disables the calculation of the dewpoint
E1	built-in NTC temperature sensor fault	automatic	stops all outputs
E2	remote temperature sensor fault	automatic	tops compensation if active, and control on average if enabled
Ert	RTC alarm	automatic	—
ALE	external alarm from digital input	automatic	signal-only alarm from external contact (humidifier)

Note: When the value is not shown in the SMALL or LARGE field, three dashes "—" are displayed.



## Technical Specifications

### General

Power supply	24 Vac +10 to -15%, 50/60Hz, 1 VA 22 to 35 Vdc, 0.5W Class 2 safety power supply Min. cable cross-section 20 AWG (0.5 mm <sup>2</sup> ). Power supply compatible with HCSteam Humidifier (G – G0)
Operating temperature	0 to 60°C 32 to 140°F, 10 to 90% rH not-condensing
Storage temperature	-20 to 70°C -4 to 158°F, 10 to 90% rH not-condensing
Precision of inside temperature measurement	± 1°C from 0 to 60°C, ± 2°C from 32 to 140°F
Precision of outside temperature measurement	± 1.5°C from 0 to 40°C ± 2.0°C from -40 to 0°C and 40 to 80°C ± 3°F from 32 to 104°F ± 4°F from -40 to 32°F and 104 to 176°F
0 to 10 V analog output, not isolated, for proportional control	precision ±5% max load 5 kΩ, max current 2 mA
Relay approval	1 AMP @ 24 Vac
Precision of humidity measurement range 10 to 90%	± 3% rH at 25°C, 77°F ± 5% rH 0 to 60°C, 32 to 140°F
Dimensions	5.3x3.4x1.4" (135x86x36 mm)
<b>Wiring</b>	
Digital input	Non-isolated version: direct connection of the voltage-free contact; contact closing current: 3 to 5 mA.
Outside temperature sensor connection with standard sensor (10K 25°C β=3435):	Maximum length: 100' (30 m), min. cable cross-section 20 AWG (0.5 mm <sup>2</sup> ).
Digital input connection	Maximum length: 33' (10 m), min. cable cross-section 20 AWG (0.5 mm <sup>2</sup> ).
Analog output connection	Maximum length: 33' (10 m), min. cable cross-section 20 AWG (0.5 mm <sup>2</sup> ).
Relay output connections:	Maximum length 100' (30 m), cable cross-section from 16 to 13 AWG (1.5 to 2.5 mm <sup>2</sup> ), class 2 reinforced insulation from the instrument.
UL specifications for connections:	Use copper wires approved for a temperature of 75°C. Minimum cross-section AWG 22-14 rigid or flexible. To tighten the terminals, apply a torque of 7 Lb/in for the black terminals (SAURO). To use the instrument in compliance with UL-873, a load with a maximum voltage 24 Vac, class 2, can be connected to the relay output.
Warning: All the connections, except for the relays, must be connected to very low voltage circuits with reinforced insulation.	

## Replacement Parts

Outdoor Temperature Sensor Cat. No. Y4103

Contact your local Lennox dealer to order replacement parts. For the Lennox dealer nearest you, dial 1-800-9-Lennox. Visit us at <http://www.Lennox.com>

